

**KLT-H3MF-OS08A20 V2.0****8MP OmniVision OS08A20 MIPI Interface M12 Fixed Focus Camera Module**

Front View

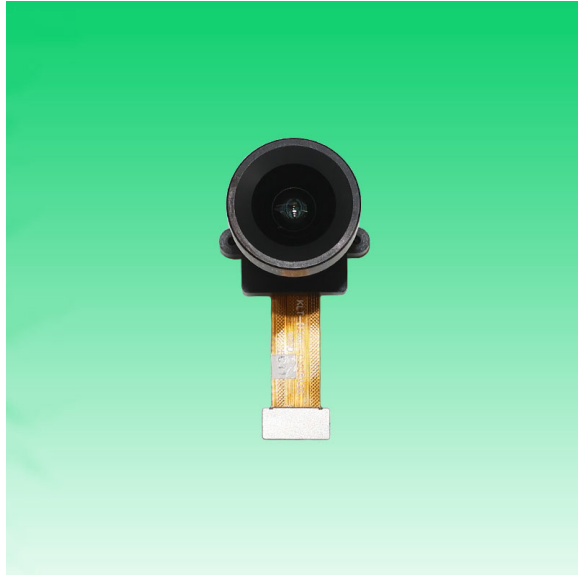

Back View

Specifications

Camera Module No.	KLT-H3MF-OS08A20 V2.0
Resolution	8MP
Image Sensor	OS08A20
Sensor Type	1/1.8"
Pixel Size	2.0 um x 2.0 um
EFL	5.00 mm
F.NO	2.00
Pixel	3840 x 2160
View Angle	105.0°(DFOV) 84.0°(HFOV) 52.0°(VFOV)
Lens Dimensions	16.40 x 16.40 x 33.67 mm
Module Size	40.00 x 22.00 mm
Module Type	Fixed Focus
Interface	MIPI
Auto Focus VCM Driver IC	None
Lens Model	KLT-LENS-PB501-06
Lens Type	650nm IR Cut
Operating Temperature	-30°C to +85°C
Mating Connector	AXE540124



KLT-H3MF-OS08A20 V2.0

8MP OmniVision OS08A20 MIPI Interface M12 Fixed Focus Camera Module



Top View



Side View

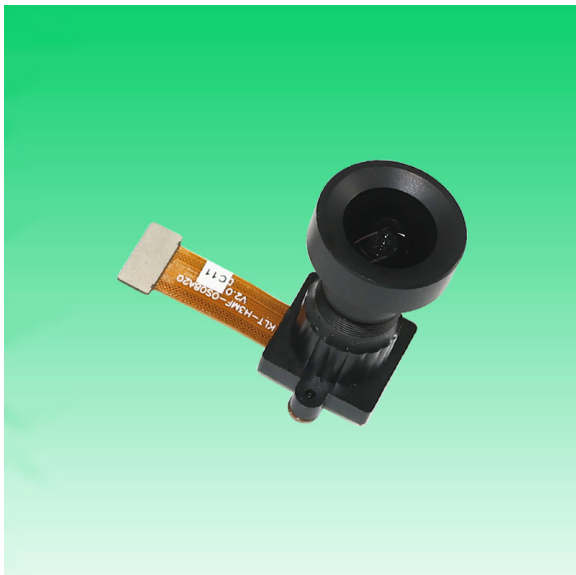

Bottom View



Mating Connector

Real Test Images H3MF-OS08A20 V2.0

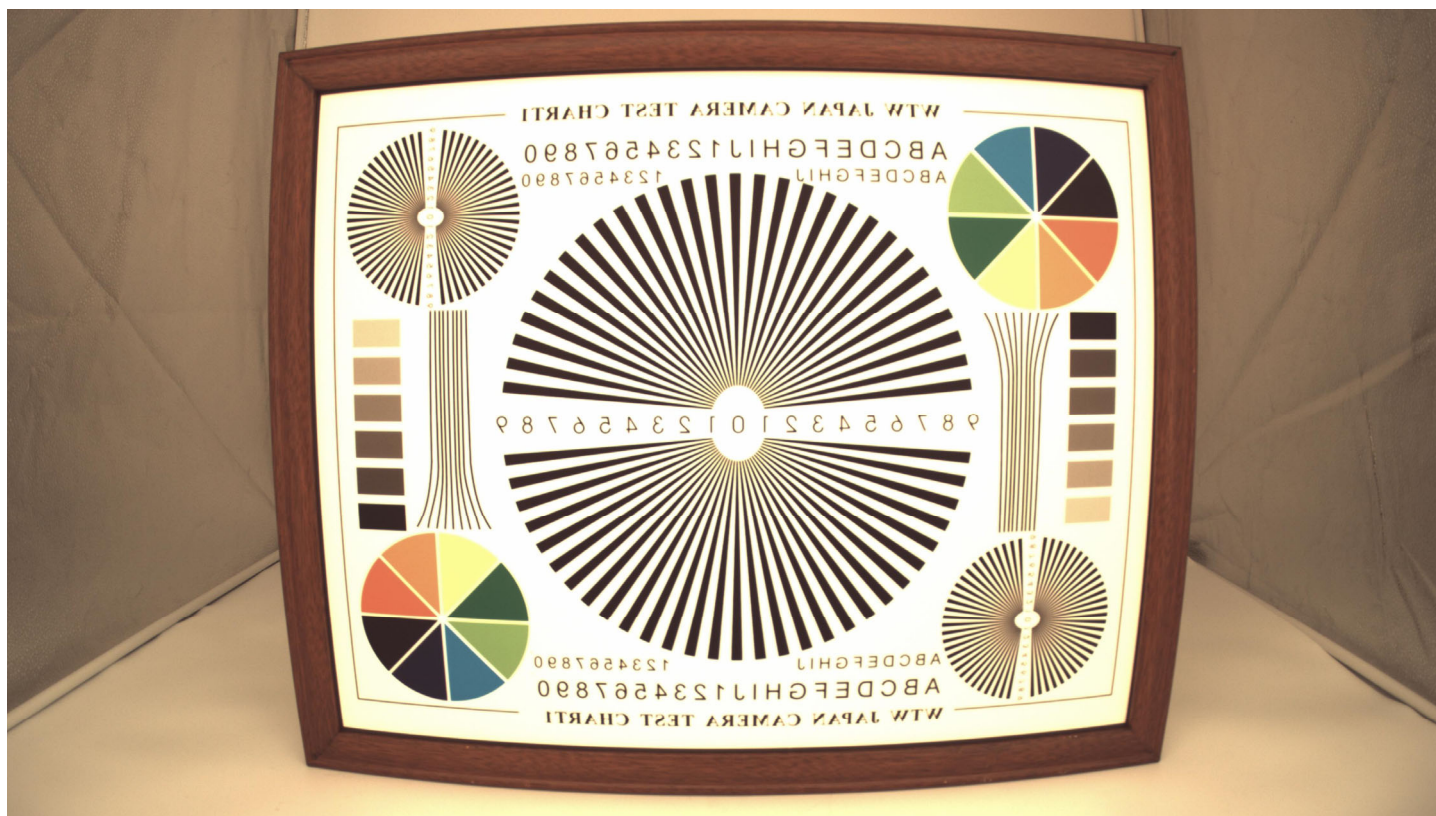

Real Test Images
H3MF-OS08A20 V2.0

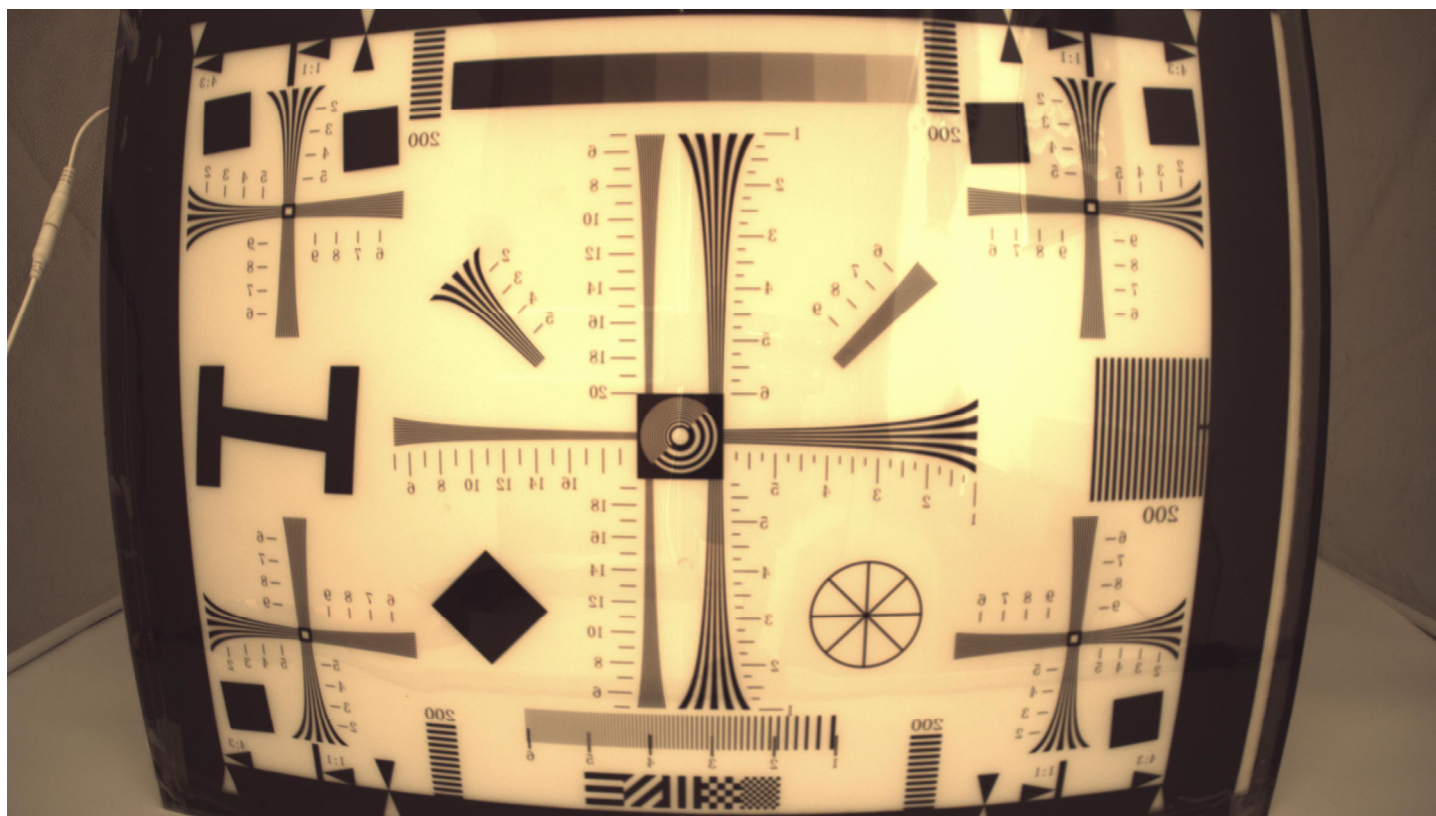

ROHS

PIN SIGNAL

1	RESET
2	PWDN
3	DGND
4	MDP0
5	MIDN0
6	DGND
7	MDP1
8	MDN1
9	DGND
10	MDP2
11	MDN2
12	DGND
13	MDP3
14	MDN3
15	DGND
16	MCP
17	MCN
18	SID
19	NC
20	NC
21	NC
22	NC
23	NC
24	NC
25	SCL
26	SDA
27	DGND
28	MCLK
29	DVDD1.2V
30	DOVDD1.8V
31	DGND
32	AVDD2.8V
33	AGND
34	DGND
35	NC
36	NC
37	NC
38	NC
39	DGND
40	DGND

Version	Information	Date
V1.0	First Version	3-11-2019
V2.0	Change lens and holder	5-14-2021

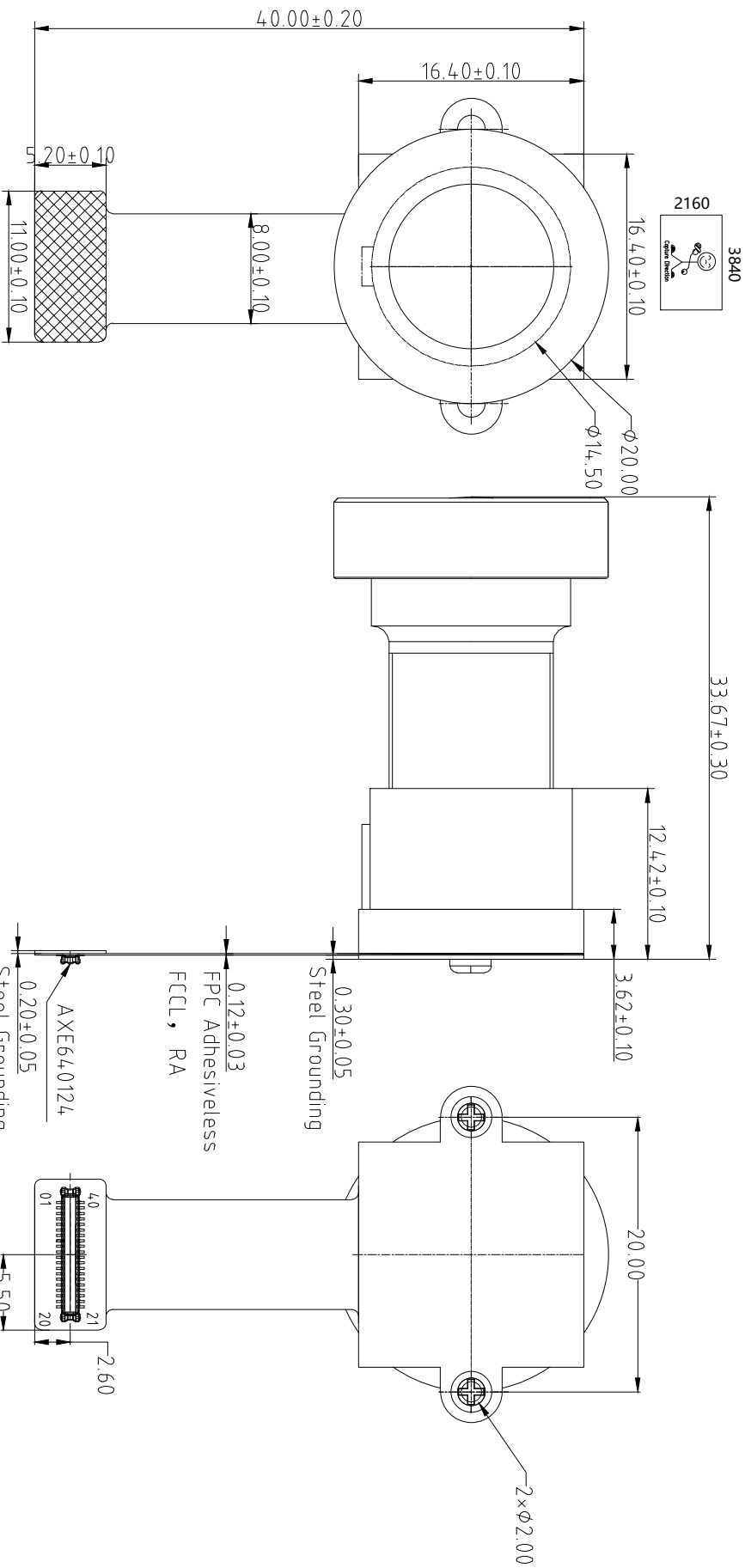

Parameter:

1、Sensor specification:

Image Sensor: OS08A20
 Pixel: 2um×2um
 Lens Type: 1/1.8
 Important Voltage Description: DVDD1.2V (external power supply);

2、Lens specification:

FOV: 105°(D),84°(H),52°(V)
 F/NO.: 2.0
 TV distortion: <7.5%
 Focal length: 5mm
 Composition: 8G+IR FILTER
 IR Cut Coating: 650nm±10nm@50%

Kai Lap Technologies Group Ltd

Designed By	Kevin	Model Name:	KLT-H3MF-OS08A20 V2.0
Checked By	Aouly Yan	Projection Type:	Third Angle
		Unif:	mm
		Scale:	1:1
		Material:	-----
		Sheet:	1 of 1
		Version:	1/0



Lens Model: KLT-LENS-PB501-06 (No IR)

三、产品规格-2

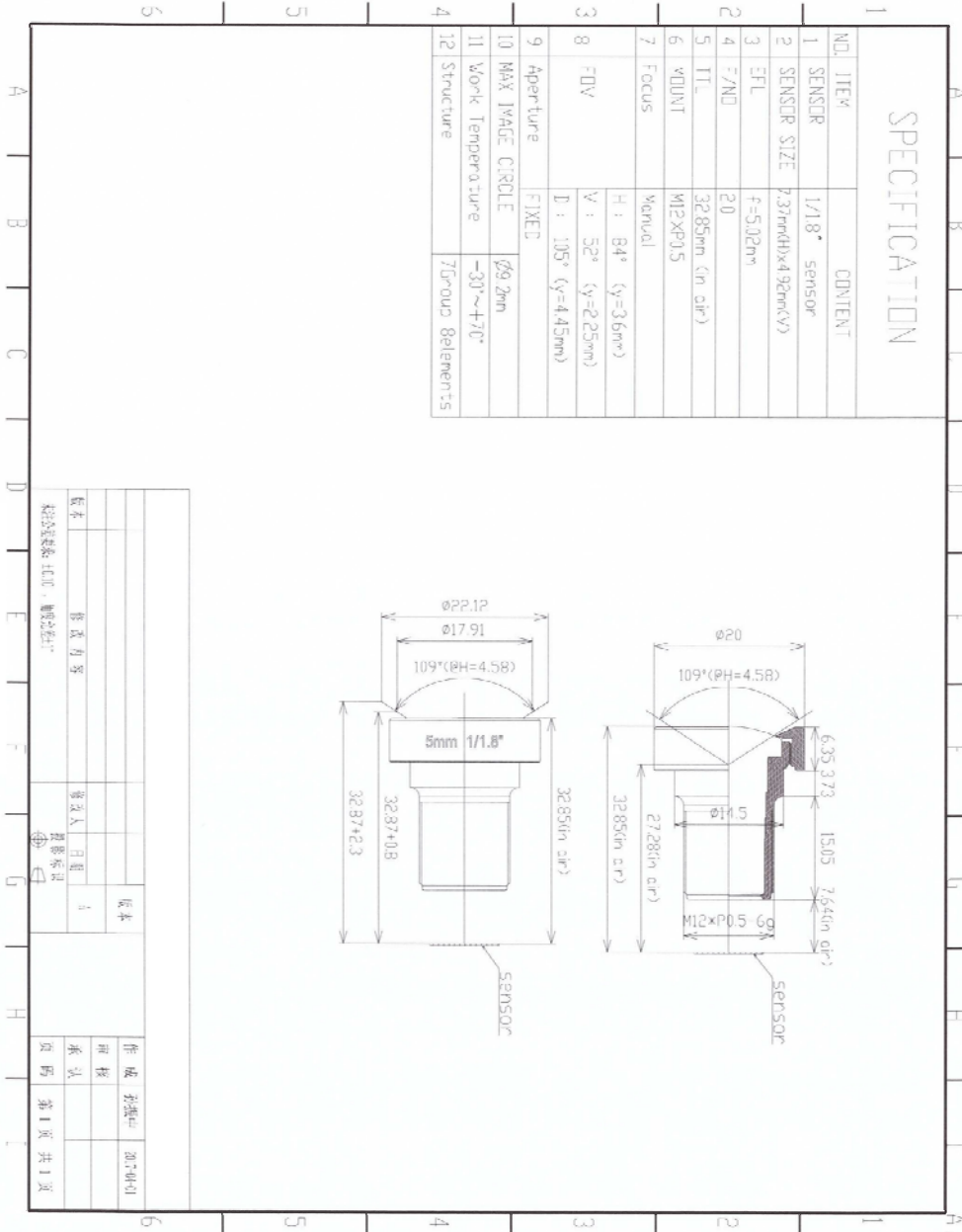

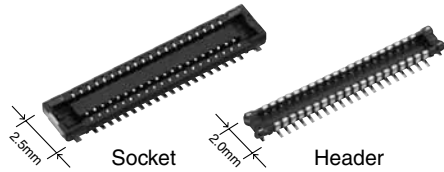

RoHS compliant

FEATURES

1. 2.5 mm wide slim two-piece style connectors

Compact and slim structure contributes overall miniaturization of product design. <Compared to F4S series (40 pin contacts, when mated)>

- Width: 30% down
- Footprint: 30% down

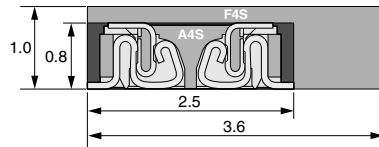

2. **"TOUGH CONTACT ADVANCED"** ensures high resistance to various environments in lieu of slim and low profile body

3. Simple lock structure provides tactile feedback to ensure excellent mating/unmating operation feel.

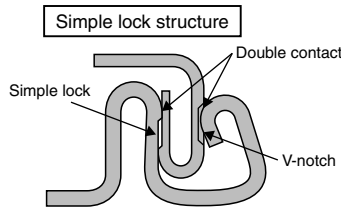

The connector gives the tactile feedback when inserted, allowing reliable mating.

- 4. Mated heights of 0.8 and 1.0 mm are available for the same foot pattern.
- 5. Connectors for inspection available

APPLICATIONS

Recommended for board-to-FPC connections of mobile equipment, such as cellular phones, smart phones, laptops, and portable music players

ORDERING INFORMATION

	AXE				2	4
5: Narrow Pitch Connector A4S (0.4 mm pitch) Socket						
6: Narrow Pitch Connector A4S (0.4 mm pitch) Header						
Number of pins (2 digits)						
Mated height						
<Socket>						
1: For mated height 0.8/1.0 mm						
<Header>						
1: For mated height 0.8 mm						
2: For mated height 1.0 mm						
Functions						
2: Without positioning bosses						
Surface treatment (Contact portion / Terminal portion)						
<Socket>						
4: Ni plating on base, Au plating on surface (for Ni barrier available)						
<Header>						
4: Ni plating on base, Au plating on surface						

PRODUCT TYPES

Mated height	Number of pins	Part number		Packing		
		Socket	Header	Inner carton (1-reel)	Outer carton	
0.8mm	10	AXE510124	AXE610124	5,000 pieces	10,000 pieces	
	12	AXE512124	AXE612124			
	14	AXE514124	AXE614124			
	16	AXE516124	AXE616124			
	18	AXE518124	AXE618124			
	20	AXE520124	AXE620124			
	22	AXE522124	AXE622124			
	24	AXE524124	AXE624124			
	26	AXE526124	AXE626124			
	28	AXE528124	AXE628124			
	30	AXE530124	AXE630124			
	32	AXE532124	AXE632124			
	34	AXE534124	AXE634124			
	36	AXE536124	AXE636124			
	38	AXE538124	AXE638124			
	40	AXE540124	AXE640124			
	44	AXE544124	AXE644124			
	50	AXE550124	AXE650124			
	1.0mm	54	AXE554124			AXE654124
		56	AXE556124			AXE656124
60		AXE560124	AXE660124			
64		AXE564124	AXE664124			
70		AXE570124	AXE670124			
80		AXE580124	AXE680124			
10		AXE510124	AXE610224			
12		AXE512124	AXE612224			
14		AXE514124	AXE614224			
20		AXE520124	AXE620224			
24		AXE524124	AXE624224			
26		AXE526124	AXE626224			
30		AXE530124	AXE630224			
32		AXE532124	AXE632224			
40	AXE540124	AXE640224				
44	AXE544124	AXE644224				
50	AXE550124	AXE650224				
54	AXE554124	AXE654224				
60	AXE560124	AXE660224				
70	AXE570124	AXE670224				
80	AXE580124	AXE680224				

- Notes: 1. Order unit:
 For volume production: 1-inner carton (1-reel) units
 Samples for mounting check: 50-connector units. Please contact our sales office.
 Samples: Small lot orders are possible. Please contact our sales office.
2. The above part numbers are for connectors without positioning bosses, which are standard. When ordering connectors with positioning bosses, please contact our sales office.
3. Please contact us for connectors having a number of pins other than those listed above.

AXE5, 6

SPECIFICATIONS

■ Characteristics

	Item	Specifications	Conditions
Electrical characteristics	Rated current	0.3A/pin contact (Max. 5 A at total pin contacts)	
	Rated voltage	60V AC/DC	
	Breakdown voltage	150V AC for 1 min.	No short-circuiting or damage at a detection current of 1 mA when the specified voltage is applied for one minute.
	Insulation resistance	Min. 1,000MΩ (initial)	Using 250V DC megger (applied for 1 min.)
	Contact resistance	Max. 90mΩ	Based on the contact resistance measurement method specified by JIS C 5402.
Mechanical characteristics	Composite insertion force	Max. 1.200N/pin contacts × pin contacts (initial)	
	Composite removal force	Min. 0.165N/pin contacts × pin contacts	
	Contact holding force (Socket contact)	Min. 0.20N/pin contacts	Measuring the maximum force. As the contact is axially pull out.
Environmental characteristics	Ambient temperature	-55°C to +85°C	No freezing at low temperatures. No dew condensation.
	Soldering heat resistance	Peak temperature: 260°C or less (on the surface of the PC board around the connector terminals)	Infrared reflow soldering
		300°C within 5 sec. 350°C within 3 sec.	Soldering iron
	Storage temperature	-55°C to +85°C (product only) -40°C to +50°C (emboss packing)	No freezing at low temperatures. No dew condensation.
	Thermal shock resistance (header and socket mated)	5 cycles, insulation resistance min. 100MΩ, contact resistance max. 90mΩ	Sequence 1. -55 ^{±3} °C, 30 minutes 2. ~, Max. 5 minutes 3. 85 ^{±3} °C, 30 minutes 4. ~, Max. 5 minutes
	Humidity resistance (header and socket mated)	120 hours, insulation resistance min. 100MΩ, contact resistance max. 90mΩ	Bath temperature 40±2°C, humidity 90 to 95% R.H.
	Saltwater spray resistance (header and socket mated)	24 hours, insulation resistance min. 100MΩ, contact resistance max. 90mΩ	Bath temperature 35±2°C, saltwater concentration 5±1%
H ₂ S resistance (header and socket mated)	48 hours, contact resistance max. 90mΩ	Bath temperature 40±2°C, gas concentration 3±1 ppm, humidity 75 to 80% R.H.	
Lifetime characteristics	Insertion and removal life	30 times	Repeated insertion and removal speed of max. 200 times/hours
Unit weight		20 pin contact type: Socket: 0.02 g Header: 0.01 g	

■ Material and surface treatment

Part name	Material	Surface treatment
Molded portion	LCP resin (UL94V-0)	—
Contact and Post	Copper alloy	Contact portion: Base: Ni plating Surface: Au plating Terminal portion: Base: Ni plating Surface: Au plating (except the terminal tips) The socket terminals close to the portion to be soldered have nickel barriers (exposed nickel portions). Soldering terminals: Sockets: Base: Ni plating Surface: Pd+Au flash plating (except the terminal tips) Headers: Base: Ni plating Surface: Au plating (except the terminal tips)

DIMENSIONS (Unit: mm)

The CAD data of the products with a **CAD Data** mark can be downloaded from: <http://industrial.panasonic.com/ac/e>

■ **Socket (Mated height: 0.8 mm/1.0 mm)**

CAD Data

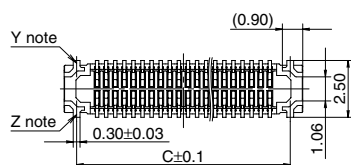
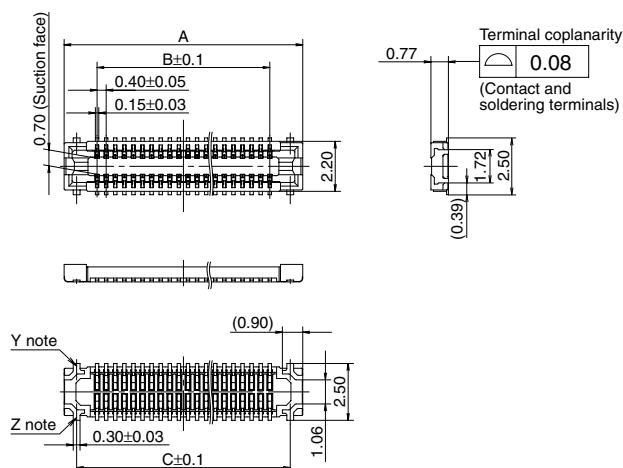
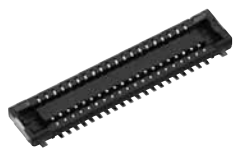

General tolerance: ±0.2

Note: Since the soldering terminals has a single-piece construction, sections Y and Z are electrically connected.

Dimension table (mm)

Number of pins/dimension	A	B	C
10	4.5	1.6	3.4
12	4.9	2.0	3.8
14	5.3	2.4	4.2
16	5.7	2.8	4.6
18	6.1	3.2	5.0
20	6.5	3.6	5.4
22	6.9	4.0	5.8
24	7.3	4.4	6.2
26	7.7	4.8	6.6
28	8.1	5.2	7.0
30	8.5	5.6	7.4
32	8.9	6.0	7.8
34	9.3	6.4	8.2
36	9.7	6.8	8.6
38	10.1	7.2	9.0
40	10.5	7.6	9.4
44	11.3	8.4	10.2
50	12.5	9.6	11.4
54	13.3	10.4	12.2
56	13.7	10.8	12.6
60	14.5	11.6	13.4
64	15.3	12.4	14.2
70	16.5	13.6	15.4
80	18.5	15.6	17.4

■ **Header (Mated height: 0.8 mm)**

CAD Data

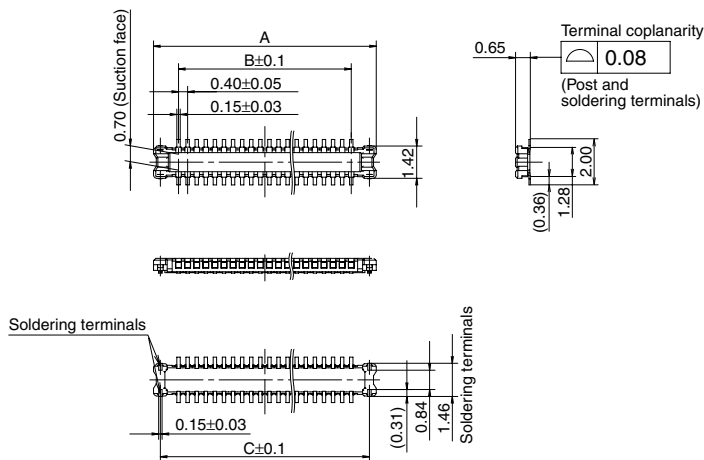

General tolerance: ±0.2

Dimension table (mm)

Number of pins/dimension	A	B	C
10	3.8	1.6	3.2
12	4.2	2.0	3.6
14	4.6	2.4	4.0
16	5.0	2.8	4.4
18	5.4	3.2	4.8
20	5.8	3.6	5.2
22	6.2	4.0	5.6
24	6.6	4.4	6.0
26	7.0	4.8	6.4
28	7.4	5.2	6.8
30	7.8	5.6	7.2
32	8.2	6.0	7.6
34	8.6	6.4	8.0
36	9.0	6.8	8.4
38	9.4	7.2	8.8
40	9.8	7.6	9.2
44	10.6	8.4	10.0
50	11.8	9.6	11.2
54	12.6	10.4	12.0
56	13.0	10.8	12.4
60	13.8	11.6	13.2
64	14.6	12.4	14.0
70	15.8	13.6	15.2
80	17.8	15.6	17.2

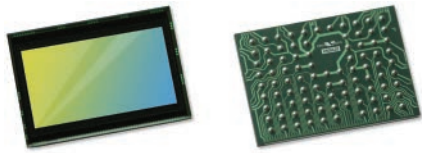

OS08A20 8-megapixel product brief



available in
a lead-free
package

High Resolution 8-Megapixel PureCel® Sensor Brings Superior Near-Infrared Imaging to Surveillance Applications

OmniVision's OS08A20 is the first 8-megapixel image sensor to combine Nyxel® technology with OmniVision's PureCel® pixel architecture, which allows the OS08A20 to capture ultra-high definition (UHD) 4K2K video and images that are bright and crisp in all lighting conditions. This makes it an ideal imaging solution for professional surveillance systems, as well as other nascent security applications such as body-worn cameras.

OmniVision's breakthrough Nyxel® technology delivers significant quantum efficiency (QE) improvements at 850 nm and 940 nm while maintaining high-modulation transfer function, allowing the OS08A20 to monitor a larger area. Additionally, by reducing the need for external lighting sources, Nyxel® technology enables lower power consumption.

The OS08A20 supports a wide range of resolution formats and frame rates, including 4K2K (3840x2160) in a 16:9 aspect ratio at 60 frames per second (fps), quad HD (2560x1440) at 60 fps, or full 1080p HD at 120 fps. It comes in a 2x2-micron pixel size and 1/1.8-inch optical format for improved sensitivity.

Find out more at www.ovt.com.



Applications

- Security Cameras
- Action Cameras
- High Resolution Consumer Cameras
- Digital Still Cameras (DSC)
- Digital Video Camcorders (DVC)

Product Features

- 2 μm x 2 μm pixel
- optical size of 1/1.8"
- QE enhancement in 850 nm and 940 nm
- programmable controls for:
 - frame rate
 - mirror and flip
 - cropping
 - windowing
- supports output formats:
 - 12-/10-bit RAW RGB
- supports image sizes:
 - 4K2K (3840x2160)
 - 2560 x 1440
 - 1080p (1920x1080)
 - 720p (1280x720)
- supports 2x2 binning
- standard serial SCCB interface
- 12-bit ADC
- up to 4-lane MIPI/LVDS serial output interface (supports maximum speed up to 1500 Mbps/lane)
- 2-exposure staggered HDR support
- programmable I/O drive capability
- light sensing mode (LSM)
- PLL with SCC support
- support for FSIN

OS08A20



Ordering Information

- OS08A20-H92A-1B (color, lead-free)
92-pin CSP

Technical Specifications

- active array size: 3840 x 2160
- maximum image transfer rate:
 - 4K2K: 60 fps
 - 2560 x 1440: 60 fps
 - 1080p: 120 fps
- power supply:
 - core: 1.2V
 - analog: 2.8V
 - I/O: 1.8V
- power requirements:
 - active: 240 mA
 - XSHUTDOWN: <math><10\ \mu\text{A}</math>
- temperature range:
 - operating: -30°C to +85°C junction temperature
 - stable image: 0°C to +60°C junction temperature
- output formats: 10/12-bit RGB RAW
- lens size: 1/1.8"
- lens chief ray angle: 11° linear
- scan mode: progressive
- pixel size: 2.0 μm x 2.0 μm
- image area: 7736.256 μm x 4379.616 μm

Functional Block Diagram

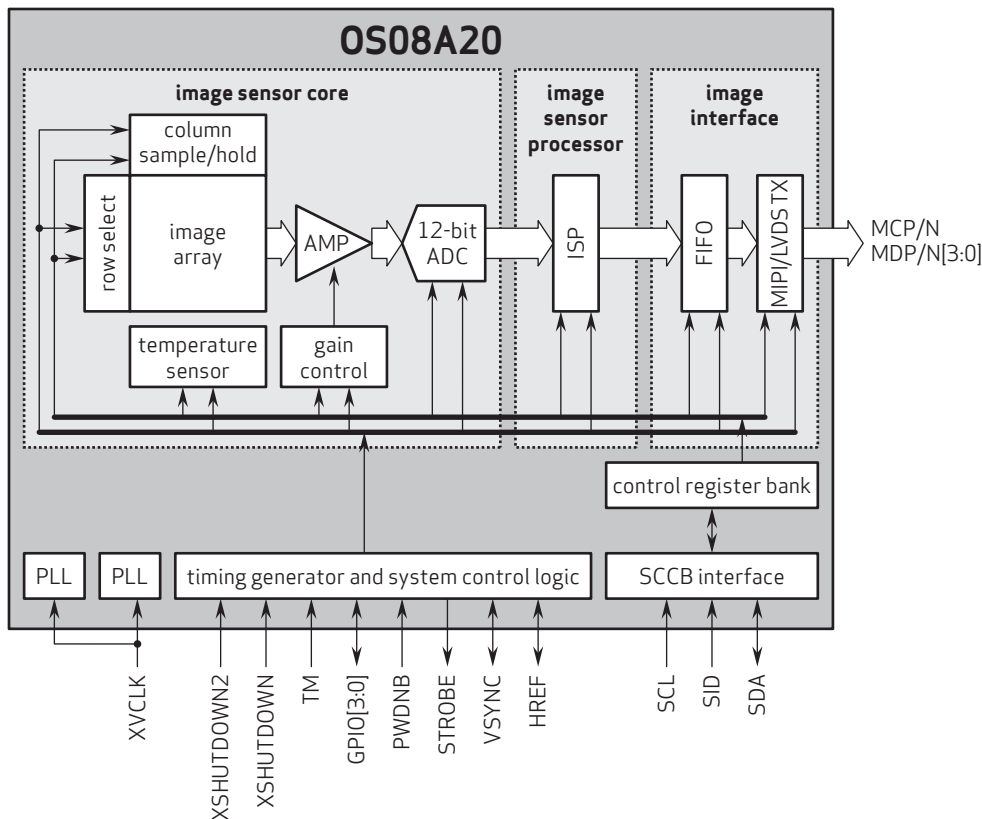

4275 Burton Drive
Santa Clara, CA 95054
USA

Tel: + 1 408 567 3000
Fax: + 1 408 567 3001
www.ovt.com

OmniVision reserves the right to make changes to their products or to discontinue any product or service without further notice. OmniVision, the OmniVision logo, PureCel, and Nyxel are registered trademarks of OmniVision Technologies, Inc. All other trademarks are the property of their respective owners.



OmniVision



Camera Module Pinout Definition Reference Chart

OmniVision	Sony	Samsung	On-Semi	Aptina	Himax	GalaxyCore	PixArt	SmartSens	Sensors
Pin Signal									
Description									
DGND	GND								
AGND									
PCLK	DCK								
XCLR	PWDN	XSHUTDOWN	STANDBY						
MCLK	XVCLK	XCLK	INCK						
RESET	RST								
NC	NULL								
SDA	SIO_D	SIOD							
SCL	SIO_C	SIOC							
VSYNC	XVS	FSYNC							
HREF	XHS								
DOVDD									
AFVDD									
AVDD									
DVDD									
STROBE	FSTROBE								
FSIN									
SID									
ILPWM									
FREX									
GPIO									
SLASEL									
AFEN									
MIPI Interface									
MDN0	DN0	MD0N	DATA_N	DMO1N					
MDP0	DP0	MD0P	DATA_P	DMO1P					
MDN1	DN1	MD1N	DATA2_N	DMO2N					
MDP1	DP1	MD1P	DATA2_P	DMO2P					
MDN2	DN2	MD2N	DATA3_N	DMO3N					
MDP2	DP2	MD2P	DATA3_P	DMO3P					
MDN3	DN3	MD3N	DATA4_N	DMO4N					
MDP3	DP3	MD3P	DATA4_P	DMO4P					
MCN	CLKN	CLK_N	DCKN						
MCP	CLKP	MCP	CLK_P	DCKN					
DVP Parallel Interface									
D0	DO0	Y0							
D1	DO1	Y1							
D2	DO2	Y2							
D3	DO3	Y3							
D4	DO4	Y4							
D5	DO5	Y5							
D6	DO6	Y6							
D7	DO7	Y7							
D8	DO8	Y8							
D9	DO9	Y9							
D10	DO10	Y10							
D11	DO11	Y11							



your BEST camera module partner

Cameras Applications

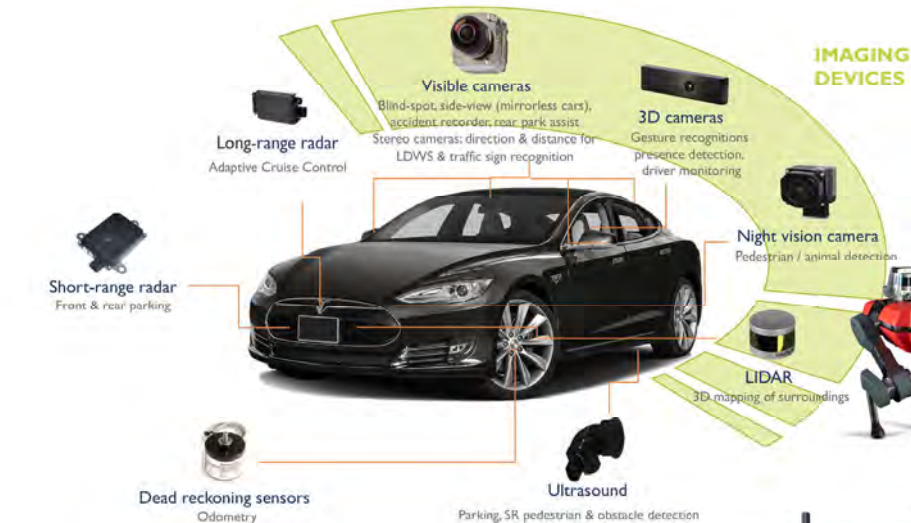



Camera Reliability Test

Reliability Inspection Item		Testing Method	Acceptance Criteria	
Category	Item			
Environmental	Storage Temperature	High 60°C 96 Hours	Temperature Chamber	No Abnormal Situation
		Low -20°C 96 Hours	Temperature Chamber	No Abnormal Situation
	Operation Temperature	High 60°C 24 Hours	Temperature Chamber	No Abnormal Situation
		Low -20°C 24 Hours	Temperature Chamber	No Abnormal Situation
	Humidity	60°C 80% 24 Hours	Temperature Chamber	No Abnormal Situation
	Thermal Shock	High 60°C 0.5 Hours Low -20°C 0.5 Hours Cycling in 24 Hours	Temperature Chamber	No Abnormal Situation
Physical	Drop Test (Free Falling)	Without Package 60cm	10 Times on Wood Floor	Electrically Functional
		With Package 60cm	10 Times on Wood Floor	Electrically Functional
	Vibration Test	50Hz X-Axis 2mm 30min	Vibration Table	Electrically Functional
		50Hz Y-Axis 2mm 30min	Vibration Table	Electrically Functional
		50Hz Z-Axis 2mm 30min	Vibration Table	Electrically Functional
	Cable Tensile Strength Test	Loading Weight 4 kg 60 Seconds Cycling in 24 Hours	Tensile Testing Machine	Electrically Functional
Electrical	ESD Test	Contact Discharge 2 KV	ESD Testing Machine	Electrically Functional
		Air Discharge 4 KV	ESD Testing Machine	Electrically Functional
	Aging Test	On/Off 30 Seconds Cycling in 24 Hours	Power Switch	Electrically Functional
	USB Connector	On/Off 250 Times	Plug and Unplug	Electrically Functional



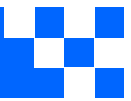

Inspection Item		Inspection Method	Standard of Inspection		
Category	Item				
Appearance	FPC/ PCB	Color	The Naked Eye	Major Difference is Not Allowed.	
		Be Torn/Chopped	The Naked Eye	Copper Crack Exposure is Not Allowed.	
		Marking	The Naked Eye	Clear, Recognizable (Within 30cm Distance)	
	Holder	Scratches	The Naked Eye	The Inside Crack Exposure is Not Allowed	
		Gap	The Naked Eye	Meet the Height Standard	
		Screw	The Naked Eye	Make Sure Screws Are Presented (If Any)	
		Damage	The Naked Eye	The Inside Crack Exposure is Not Allowed	
	Lens	Scratch	The Naked Eye	No Effect On Resolution Standard	
		Contamination	The Naked Eye	No Effect On Resolution Standard	
		Oil Film	The Naked Eye	No Effect On Resolution Standard	
		Cover Tape	The Naked Eye	No Issue On Appearance.	
	Function	Image	No Communication	Test Board	Not Allowed
			Bright Pixel	Black Board	Not Allowed In the Image Center
Dark Pixel			White board	Not Allowed In the Image Center	
Blurry			The Naked Eye	Not Allowed	
No Image			The Naked Eye	Not Allowed	
Vertical Line			The Naked Eye	Not Allowed	
Horizontal Line			The Naked Eye	Not Allowed	
Light Leakage			The Naked Eye	Not Allowed	
Blinking Image			The Naked Eye	Not Allowed	
Bruise			Inspection Jig	Not Allowed	
Resolution			Chart	Follows Outgoing Inspection Chart Standard	
Color			The Naked Eye	No Issue	
Noise			The Naked Eye	Not Allowed	
Corner Dark			The Naked Eye	Less Than 100px By 100px	
Color Resolution			The Naked Eye	No Issue	
Dimension	Height	The Naked Eye	Follows Approval Data Sheet		
	Width	The Naked Eye	Follows Approval Data Sheet		
	Length	The Naked Eye	Follows Approval Data Sheet		
	Overall	The Naked Eye	Follows Approval Data Sheet		



KLT Package Solutions

KLT Camera Module

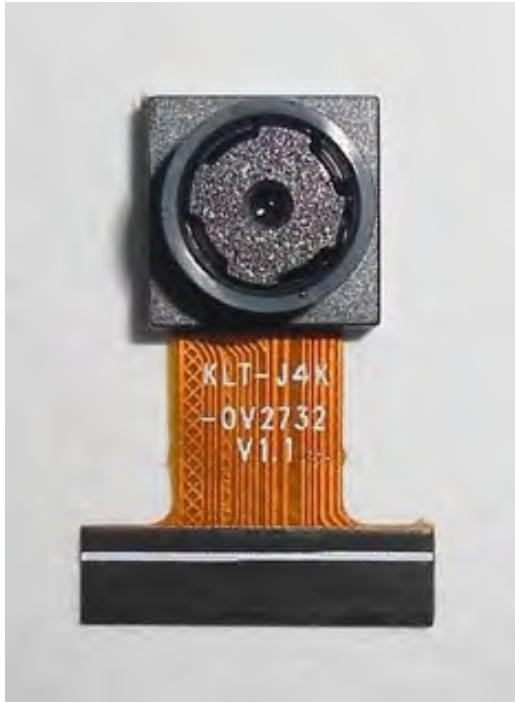

Complete with Lens Protection Film



Tray with Grid and Space



Place Cameras on the Tray

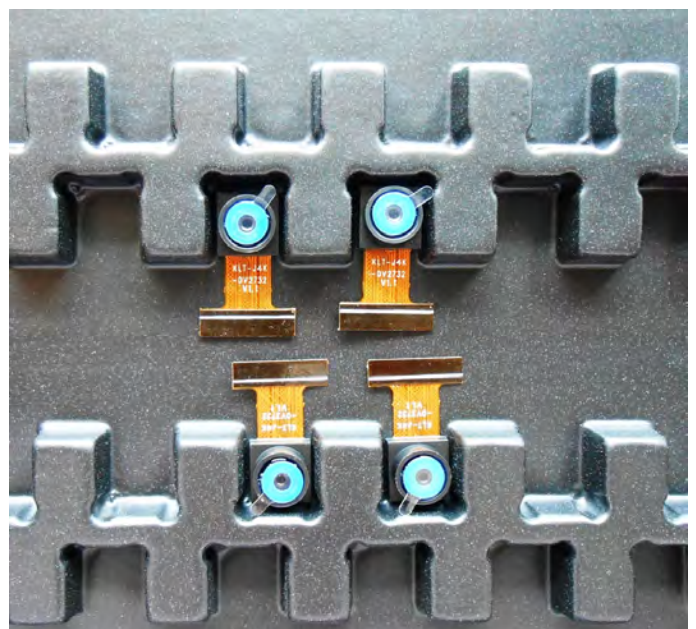



Camera Modules Package Solution

Full Tray of Cameras



Cover Tray with Lid



Put Tray into Anti-Static Bag



Vacuum the Anti-Static Bag

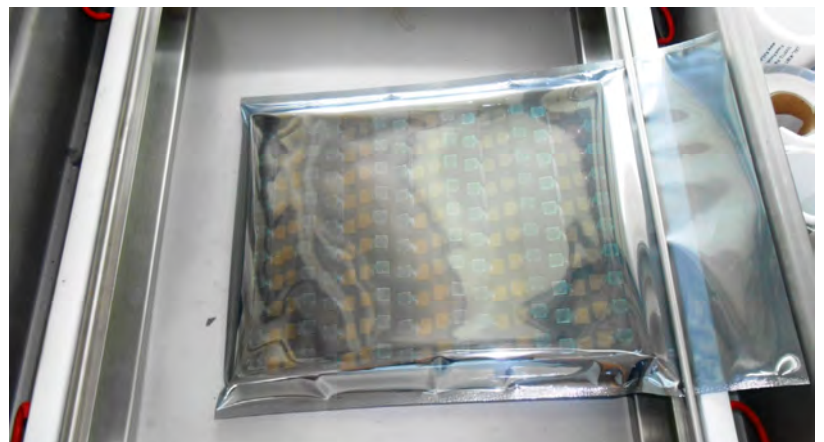



Camera Modules Package Solution

Sealed Vacuum Bag with Labels

1. Model and Description 2. Quantity 3. Shipping Date 4. Caution





Large Order Package Solution

Place Foam Sheets Between Trays



Foam Sheets are Slightly Larger than Trays



Place Foam Sheets and Trays into Box



Foam Sheets are Tightly Fitting Box





Small Order Package Solution

Place Foam Sheets and Trays into Small Box



Foam Sheets are Nicely Fitting the Small Box



Package in Small Box for Shipment



Place Small Boxes into Larger Box





Carbon Box Package Solution

Seal the Carbon Box

Final Package Labelled Box



Carbon Box Ready for Shipment

1. Delivery Address and Phone No. 2. Box No. and Ship Date 3. Fragile Caution





Sample Order Package Solution

Place Sample into Small Anti-Static Bag



Place Connectors into Small Ant-Static Bag



Sample Labels on the Small Bag

1. Camera Module or Connector Model
2. Shipping Date and Quantity
3. Caution





Connectors Large Order Package Solution

Connectors in a Wheel



Label Connectors in the Wheel



The Wheel is Perfectly Fitting the Box



Connectors Box Ready for Shipment





Company Kai Lap Technologies (KLT)

Kai Lap Technologies Group Limited. (KLT) was established in 2009, a next-generation technology driven manufacturer specialized in research, design, and produce of audio and video products. KLT is occupying 20,000 square feet automated plants with 100 employees of annual throughput 30,000,000 units cameras.

KLT provides OEM, ODM design, contract manufacturing, and builds the camera products. You may provide the requirements to us, even with a hand draft, our sales and engineering work together to meet your needs. We consider ourselves your last-term partner in developing practical and innovative solutions.

Our team covers everything from initial concept development to mass produced product. KLT specializes in customized camera design, raw material, electronic engineering, firmware/software development, product testing, and packing design. Our experienced strategic supply systems offer a robust and dependable manufacturing capacity for orders of various sizes.

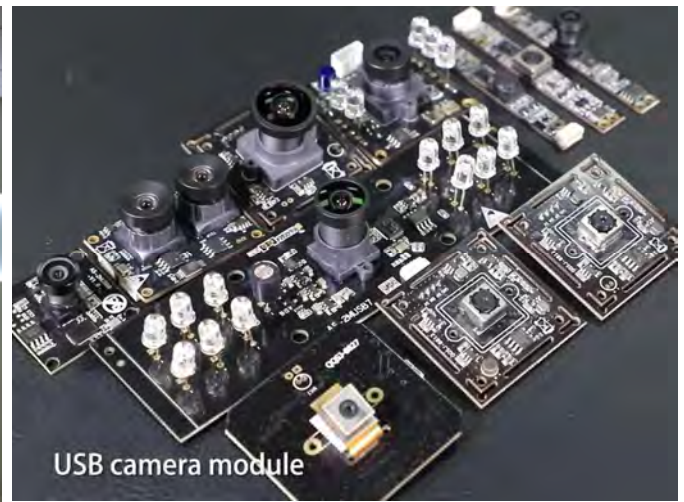

Limited Warranty

KLT provides the following limited warranty if you purchased the Product(s) directly from KLT company or from KLT's website, www.KaiLapTech.com. Product(s) purchased from other sellers or sources are not covered by this Limited Warranty. KLT guarantees that the Product(s) will be free from defects in materials and workmanship under normal use for a period of one (1) year from the date you receive the product ("Warranty Period").

For all Product(s) that contain or develop material defects in materials or workmanship during the Warranty Period, KLT will, at its sole option, either: (i) repair the Product(s); (ii) replace the Product(s) with a new or refurbished Product(s) (replacement Product(s) being of identical model or functional equivalent); or (iii) provide you a refund of the price you paid for the Product(s).

This Limited Warranty of KLT is solely limited to repair and/or replacement on the terms set forth above. KLT is not reliable or responsible for any subsequent events.





CMOS CAMERA MODULES



your BEST camera module partner

KLT Strength

Powerful Factory



Professional Service



Promised Delivery



www.KaiLapTech.com sales@KaiLapTech.com Tel: (852) 6908 1256 Fax: (852) 3017 6778

All rights reserved @ Kai Lap Technologies Group Ltd. Specifications subject to change without notice.